

16.706.01..0000

SANIT Push plate S706 alpine white

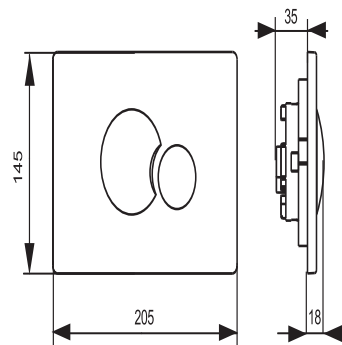
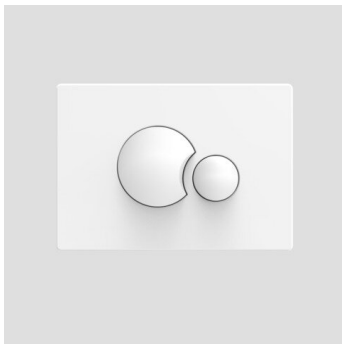

Item number

16.706.01..0000

Product description

Push plate S 706

l/w/h: 205/145/18 mm, plastic, for concealed cisterns with small access opening, dual flush, consisting of actuator frame, push buttons, support bracket and fixing bolts, packed in a box

Material/colour: plastic/alpine white