

03.016.00..0099

SANIT Pipe trap with ventilair Air adm.valve G1 1/2xDN56

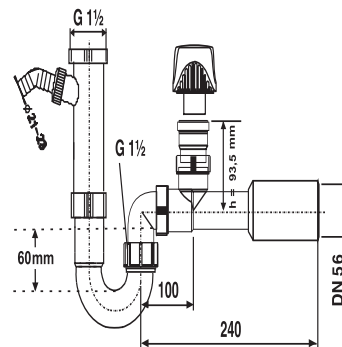

Item number

03.016.00..0099

Product description

Pipe trap with ventilair air admittance valve G1 1/2 x DN 56 plastic, with connection pipe 250 mm and hose tap, in accordance with DIN (test number 4 U 046), extension pipe with ventilair air admittance valve, type-tested and monitored according to DIN EN 12380 by TÜV Rheinland LGA Products GmbH, type class A I, volume flow 8 l/s, temperature range -20degC to +60degC, with additional testing to DIN EN 274, temperature range up to +95degC